

# CI

Datasheet

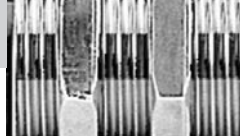

## Noncontact Temperature Measurement for Industrial Applications



## CI Highlights

- Type J or K, or 0-5 V output
- Two models cover temperature ranges from 0°C to 500°C (32°F to 932°F)
- IP 65 (NEMA-4) stainless steel electronics housing
- 4:1 optics at 90% energy
- 350 mSec (95%) response time
- Powered by 12–24 VDC at 20 mA
- Accessories for cooling and air purging

The Raytek CI model provides the advantages of infrared temperature measurement in a compact, low cost, integrated sensor. Designed for easy integration into a standard 4-wire system, the CI sensor can easily replace traditional contact probes with a J-type or K-type thermocouple output, or with a 0-5 volt output if your application is susceptible to noise or requires a longer cable run.

The CI sensor is designed to measure target temperatures ranging from 0°C to 500°C (32°F to 932°F). The CI unit's onboard electronics are protected by a rugged IP 65 (NEMA-4) stainless steel housing, allowing the sensor to function in ambient temperatures to 70°C (160°F) without cooling. With water cooling, the CI sensor can withstand ambient temperatures to 260°C (500°F).

Because the CI unit has the same 50 Ohm output impedance as a thermocouple, it functions accurately—without offset errors—when used in conjunction with the thermocouple break protection circuitry in most controllers, displays, and transmitters.

Compact. Easy to install. Affordable. The Raytek CI sensor is ideal for both OEM and end-user applications.

## Measurement Specifications

Model	Output	Overall Temp. Range	Accuracy
CI1A	J Thermocouple	0°C to 350°C (32°F to 662°F)	0°C to 115°C (32°F to 240°F) ±3°C (±6°F)
CI2A	K Thermocouple		116°C to 225°C (241°F to 440°F) larger of ±5%
CI3A	Voltage		226°C to 350°C (441°F to 662°F) >±5%
CI1B	J Thermocouple	30°C to 500°C (86°F to 932°F)	100°C to 500°C (212°F to 932°F) larger of ±2% or ±3°C (±6°F)
CI2B	K Thermocouple		30°C to 99°C (86°F to 211°F) ±6°C (±10°F)
CI3B	Voltage		

Spectral Response	7 to 18 microns
System Repeatability	±1% of measured value or ±1°C (2°F), whichever is greater
Temperature Resolution	<0.5°C or 1°F
Response Time (95%)	350 mSec
Emissivity	Fixed at 0.95

## Nominal Optical Specifications

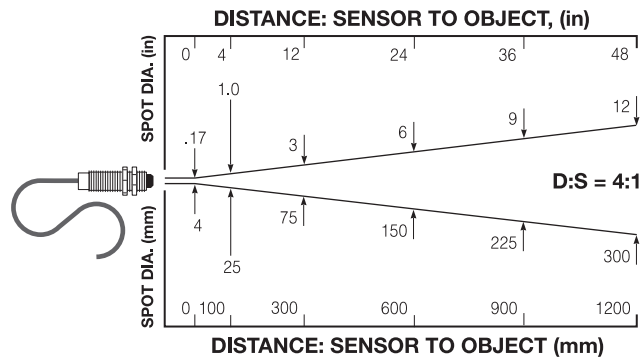

D:S is the optical resolution expressed as a ratio of the distance to the resolution spot divided by the diameter of the spot.

Optical resolution for the CI sensor is 4:1. Nominal spot size based on 90% energy.

## Electrical Specifications

Outputs	User-selectable thermocouple output (model specific, either J or K) or voltage output 10 mV/°C
Cable Length	1 m (3.2 ft) standard, longer cables optional
Output Impedance	50 ohms
Minimum Load Impedance	50K ohms
Power Supply	12–24 VDC ( $\leq 2.5\%$ ripple) @ 20 mA

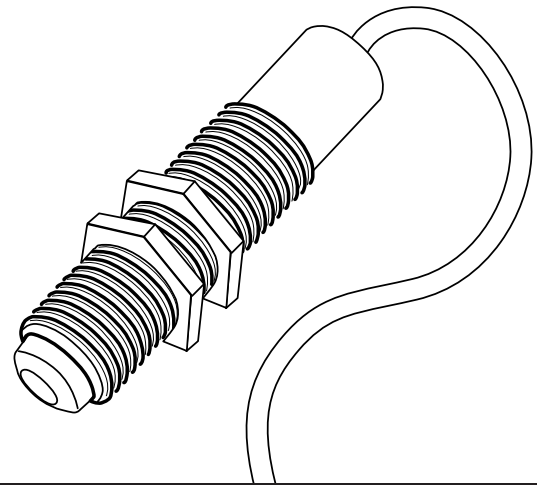

## Accessories Options

Each CI sensor includes two mounting nuts, 1m (3.2ft.) of cable, and an operator's manual. Longer cables up to 15m (50ft.) maximum are available and must be specified at the time of order.

## Sensor Specifications

Environmental Rating	IP 65 (NEMA-4)
Ambient Temperature Range	0°C to 70°C (32°F to 160°F)
With air cooling	0°C to 90°C (32°F to 200°F)
With water cooling	0°C to 260°C (32°F to 500°F)
Storage Temperature	-30°C to 85°C (-22°F to 185°F)
Relative Humidity	10 to 95%, non-condensing
Shock	IEC 68-2-27 (MIL STD 810D) 50 g's, 11 mSec, any axis
Vibration	IEC 68-2-27 (MIL STD 810D) 3 g's, any axis, 11–200 Hz
Weight	130 g (4.5 oz)

Adjustable or fixed mounting bracket for sensing head (XXXCIADJB or XXXCIACFB)

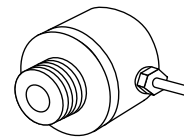
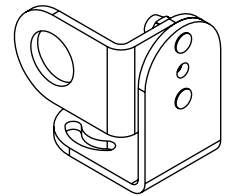

Air purge jacket to keep lens or right angle mirror clean (XXXCIAP or XXXCIACAPM for metric version)

Right angle mirror to ease installation into tight locations (XXXCIACRA)

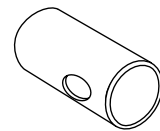

## Sensor Dimensions

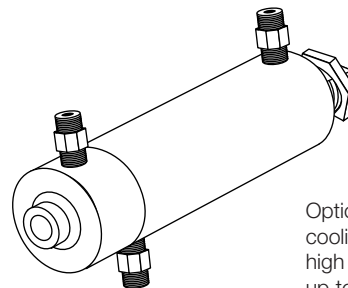
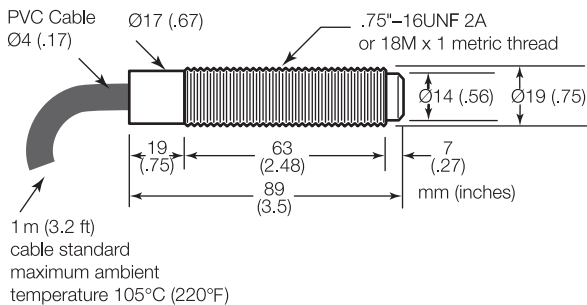

Optional water/air cooling/purging system for high temperature environments up to 260°C (500°F)

Optional cooling jacket must be specified at the time of order.



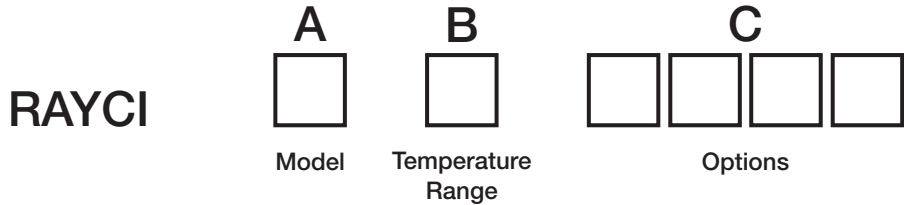

Model	Description
RAYCI	Raytek infrared temperature sensor
Code A	Response
1	Type J Thermocouple Output
2	Type K Thermocouple Output
3	Voltage Output (Linear 10 mV / °C, scaled 0-5V)
Code B	Temperature Range
A	±2% or ±3°C accuracy between 0°C and 115°C (32°F to 240°F)
B	±2% or ±3°C accuracy between 100°C and 500°C (212°F to 932°F)
Code C	Options
M	18Mx1 metric thread on sensor in place of standard thread
W	Water cooled jacket with built-in air purging and 1m (3') high temperature cable
Typical Model Number	RAYCI1AW

## Raytek Automation Products: Noncontact Temperature Measurement for Industrial Applications

Raytek Corporation  
 Worldwide Headquarters  
 1201 Shaffer Rd. Bldg. 2  
 Santa Cruz, CA 95060-5731 USA  
 Tel: 1 800 227 8074  
 1 831 458 1110  
 Fax: 1 831 458 1239  
 solutions@raytek.com

**www.raytek.com**  
*for up-to-the-minute features*

To find a Raytek office near you please visit [www.raytek.com](http://www.raytek.com)

### Worldwide Service

Raytek offers services including emergency repairs and calibration.  
 For more information, contact your local office or e-mail: [support@raytek.com](mailto:support@raytek.com)



Raytek is an ISO 9001 certified company

© 2006 Raytek Corporation (2-1302 Rev. E) 7/2006  
 Raytek and the Raytek logo are registered trademarks and  
 Compact Series and CI are trademarks of Raytek Corporation.  
 Specifications subject to change without notice.